

Integrating Kafka with
Enterprise Java for
establishing a high
performant distributed
messaging
infrastructure

Anamarija Talijanac, Irena Kezić

IBM Services

13th May, 2019

Agenda

- Kafka basics
- Kafka Use Cases
- Java Connector Architecture
- Distributed messaging challenges
- Reliable Kafka Processing
- IBM Event Streams

Architectural overview

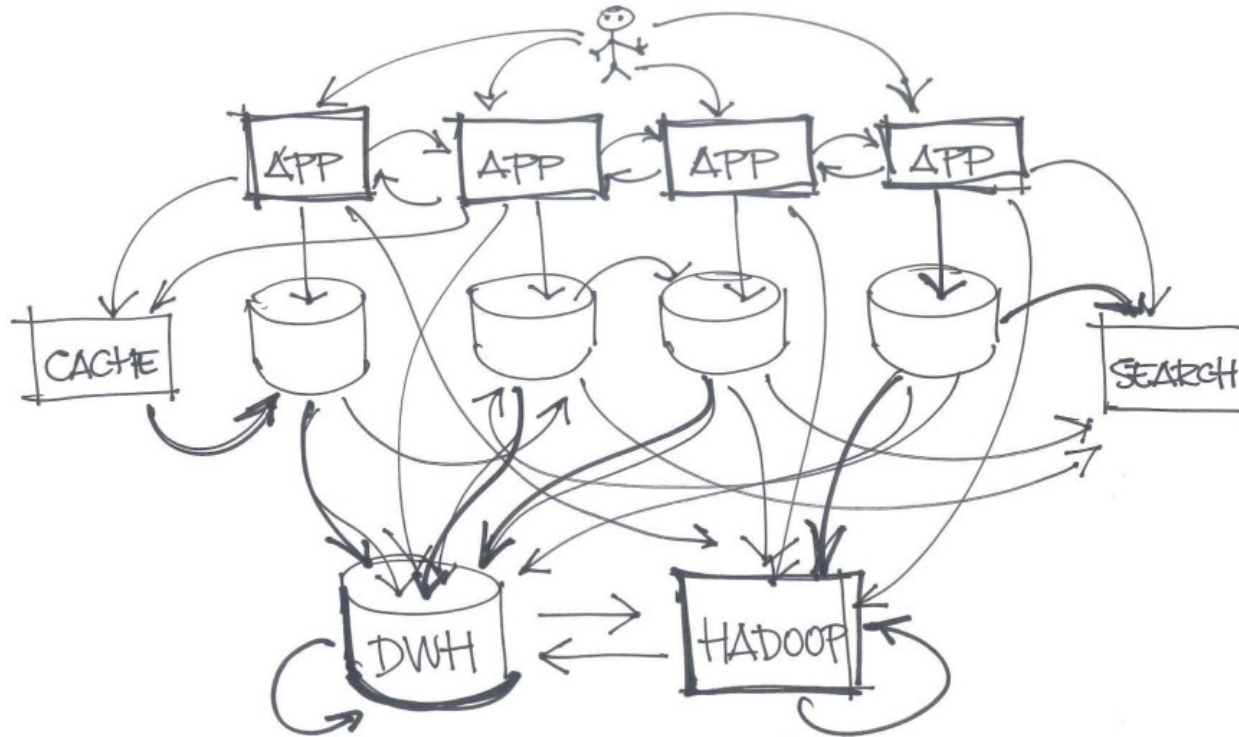

Architectural overview

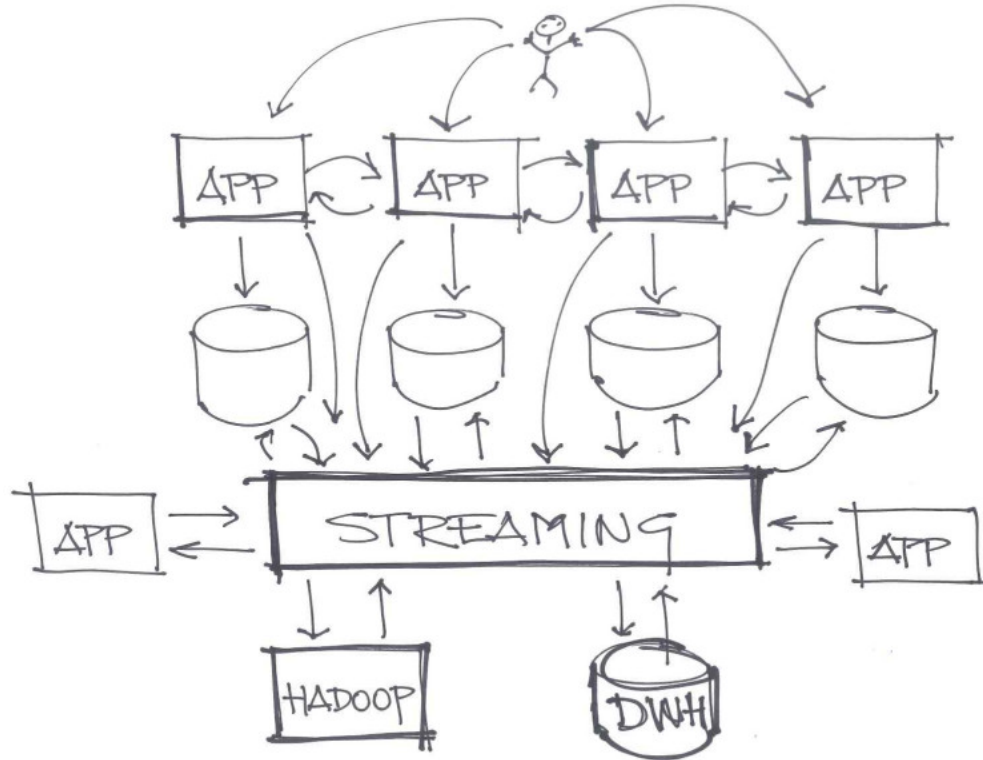

Kafka basics



HIGH
THROUGHPUT



DURABILITY



RELIABILITY

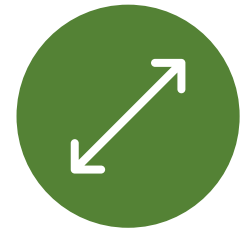

SCALABILITY

Kafka basics

- Cluster / Broker
- Topic / Partition
- Producer / Consumer

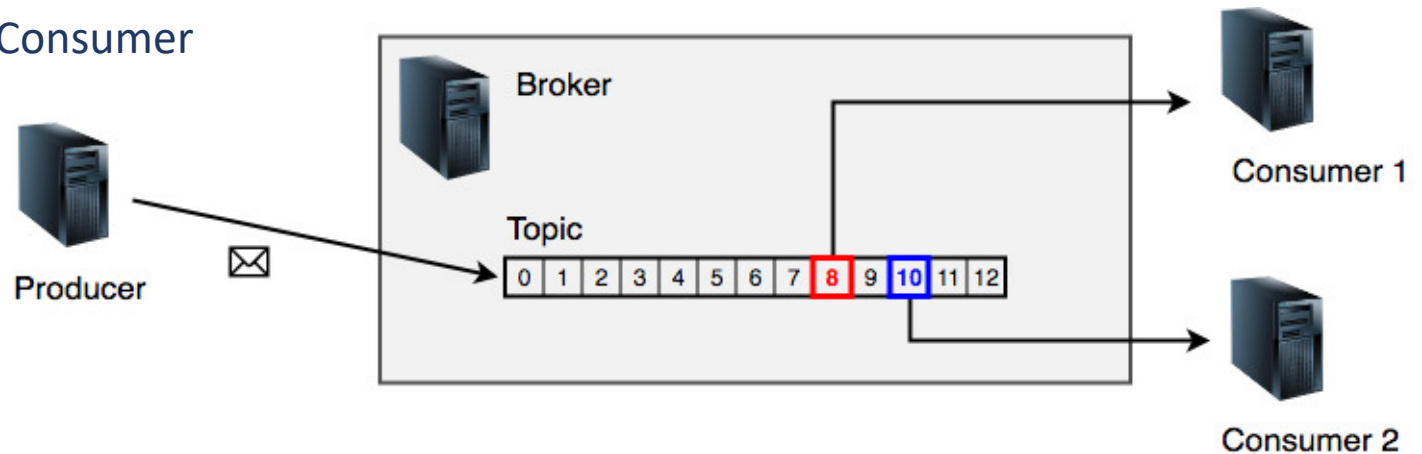

Kafka Use Cases

- Activity tracking
- Commit Log
- Metrics and Logging
- Unit of Order
- Stream processing

Java Connector Architecture

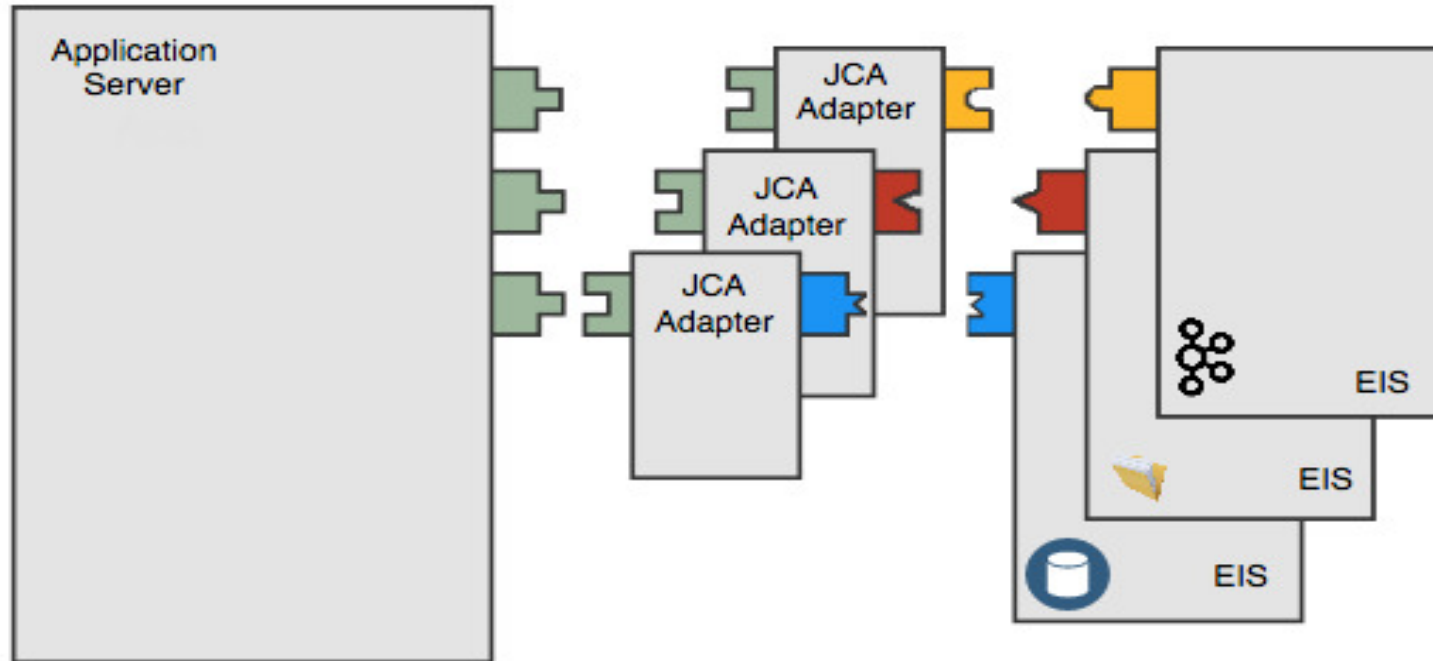

Java Connector Architecture

- The Java EE standard for integrating application servers with EIS.
- Unified common client interface for heterogeneous resource providers

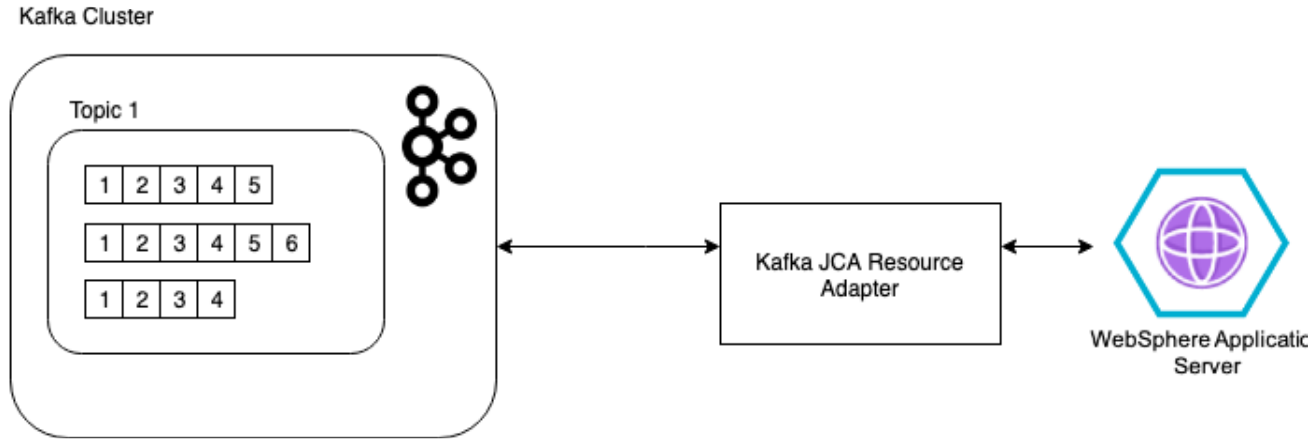

Java Connector Architecture

- Lifecycle management Contract
- Work management Contract
- Connection Management Contract
- Transaction Management Contract
- Security Contract
- Transaction Inflow Contract
- Message Inflow Contract
- Generic Context Contract



Distributed messaging challenges



EXACTLY ONCE
DELIVERY



GUARANTEED ORDER
OF MESSAGES



RELIABLE MESSAGING

XA with Kafka



BEGIN
TRANSACTION



CONSUME MESSAGE
FROM KAFKA TOPIC



INSERT ROW INTO
TARGET DATABASE

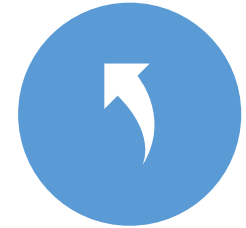

COMMIT
TRANSACTION

Reliable Kafka Processing

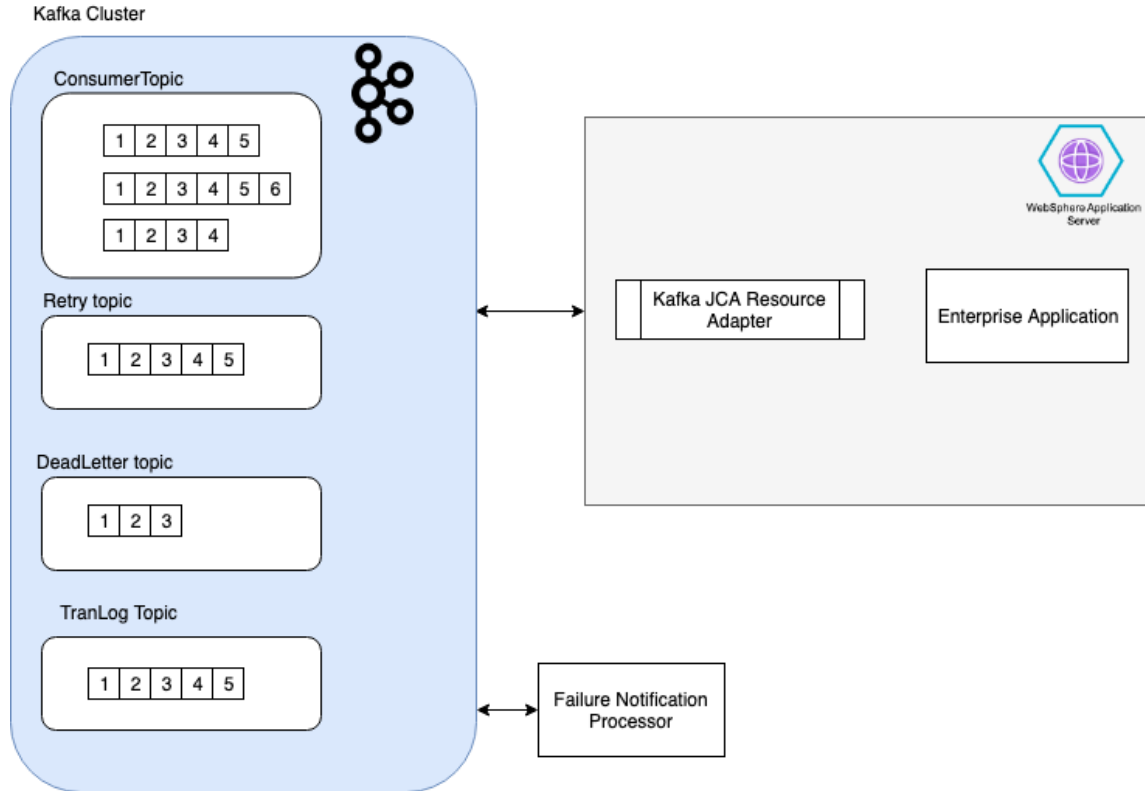

Reliable Kafka Processing

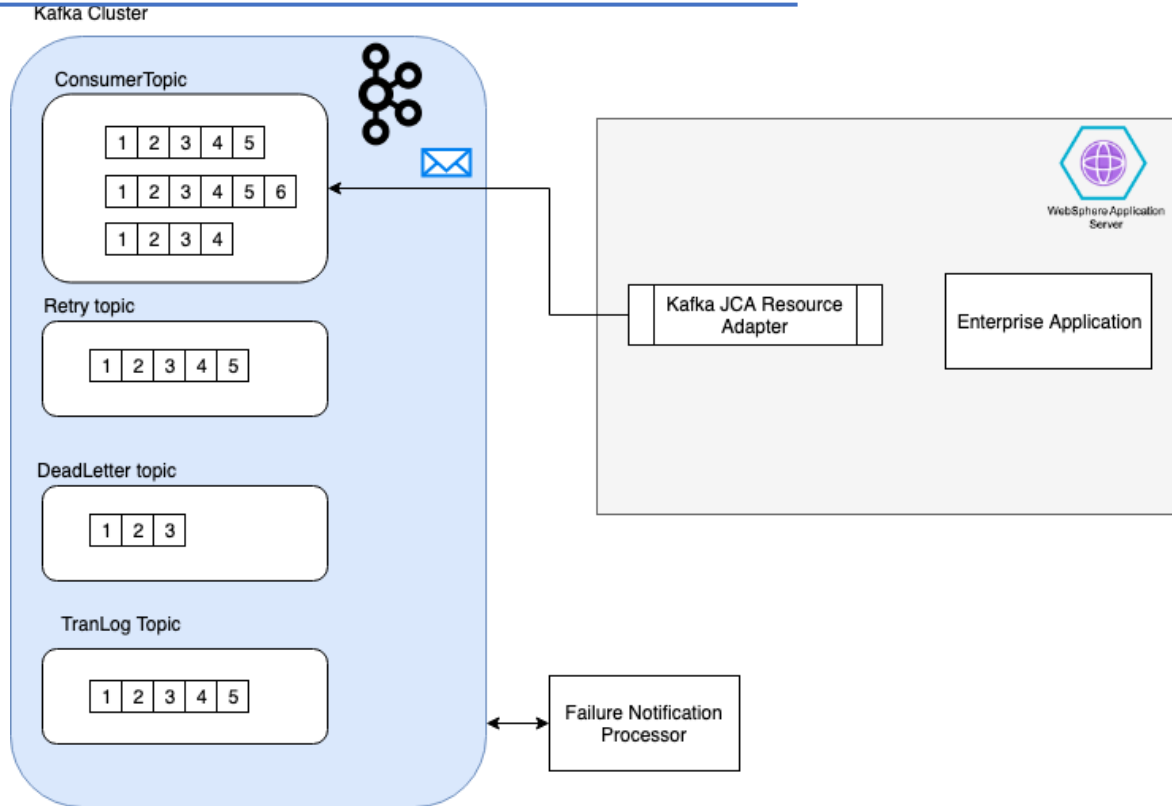

Reliable Kafka Processing

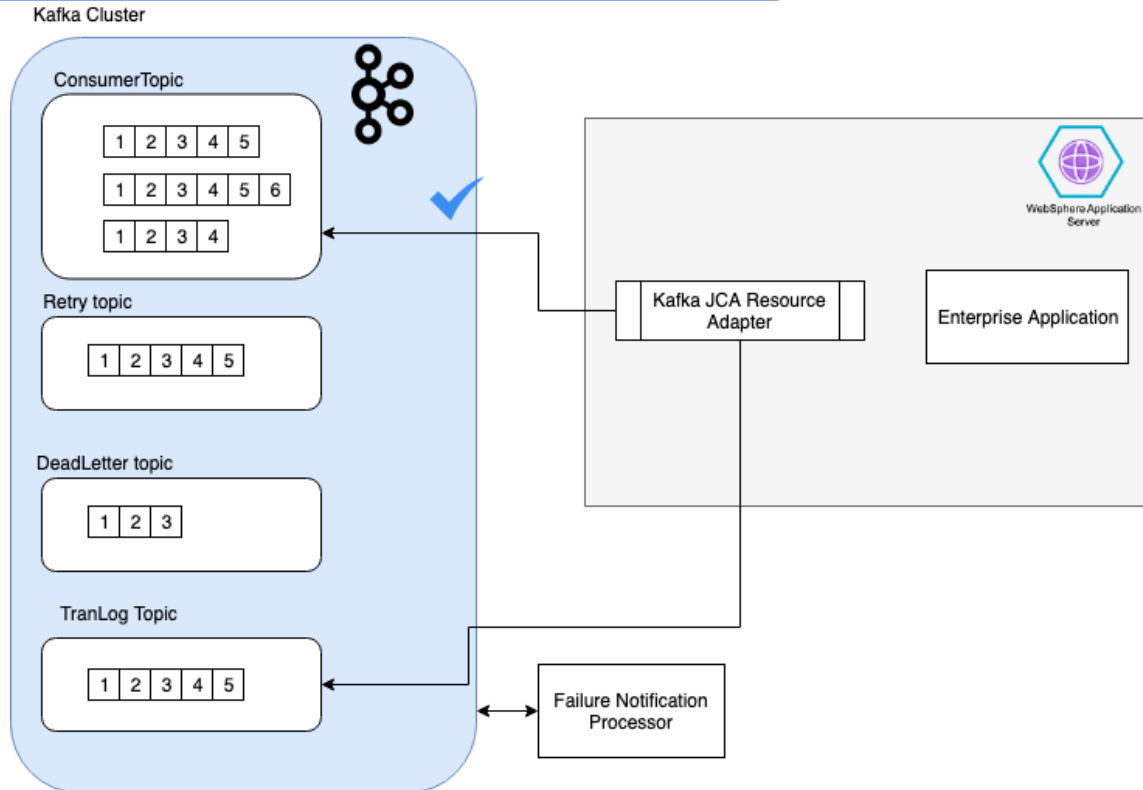

Reliable Kafka Processing

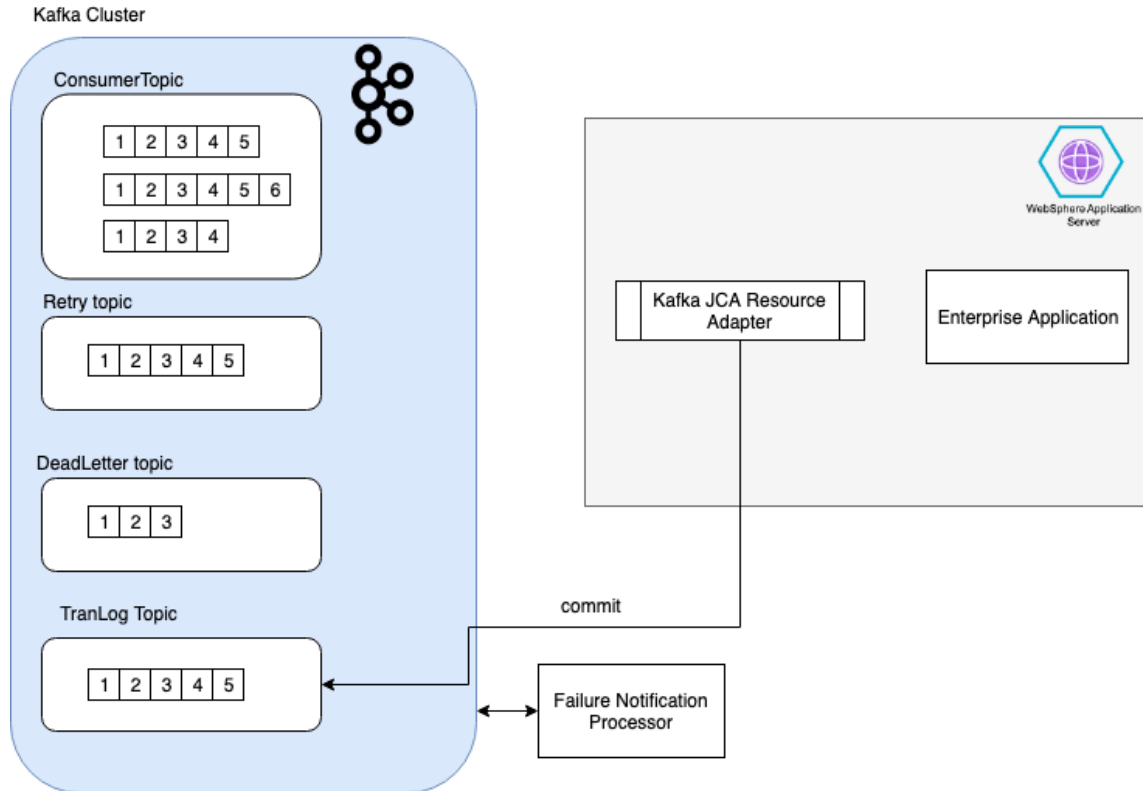

Reliable Kafka Processing

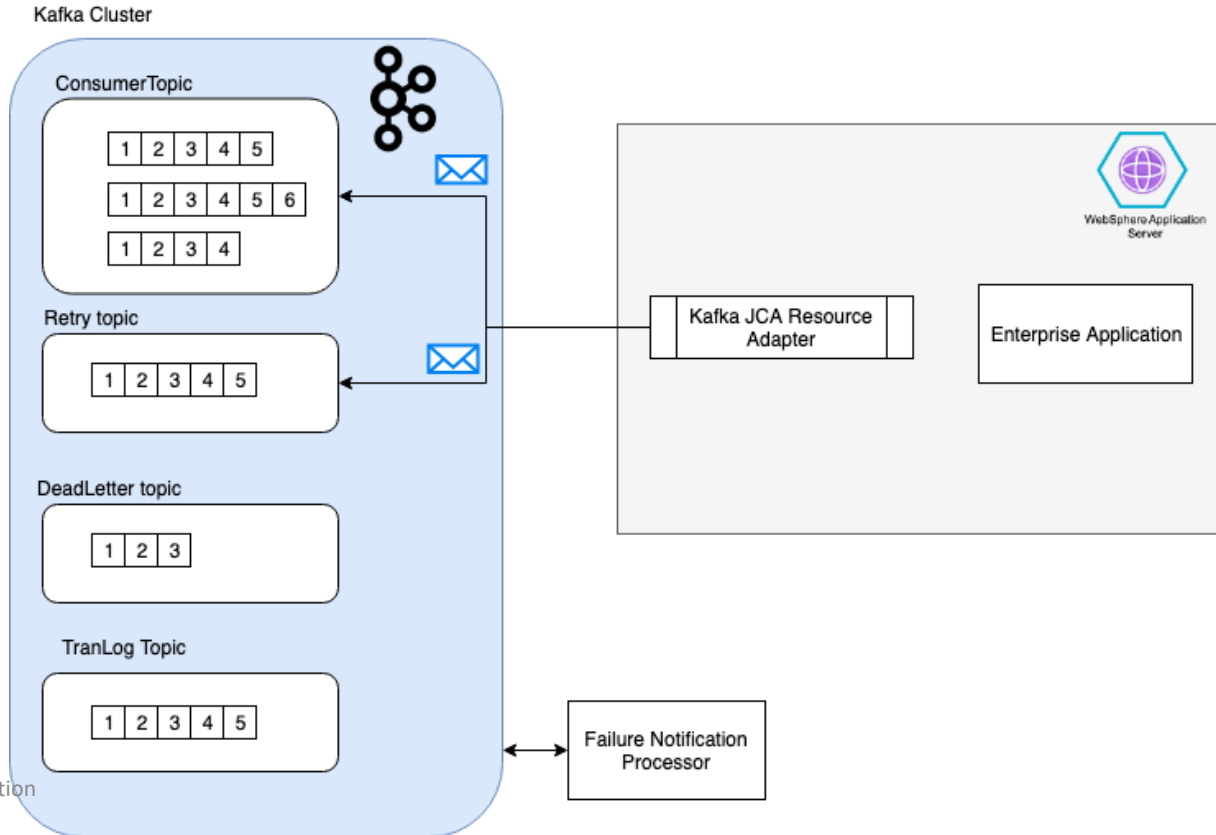

Reliable Kafka Processing

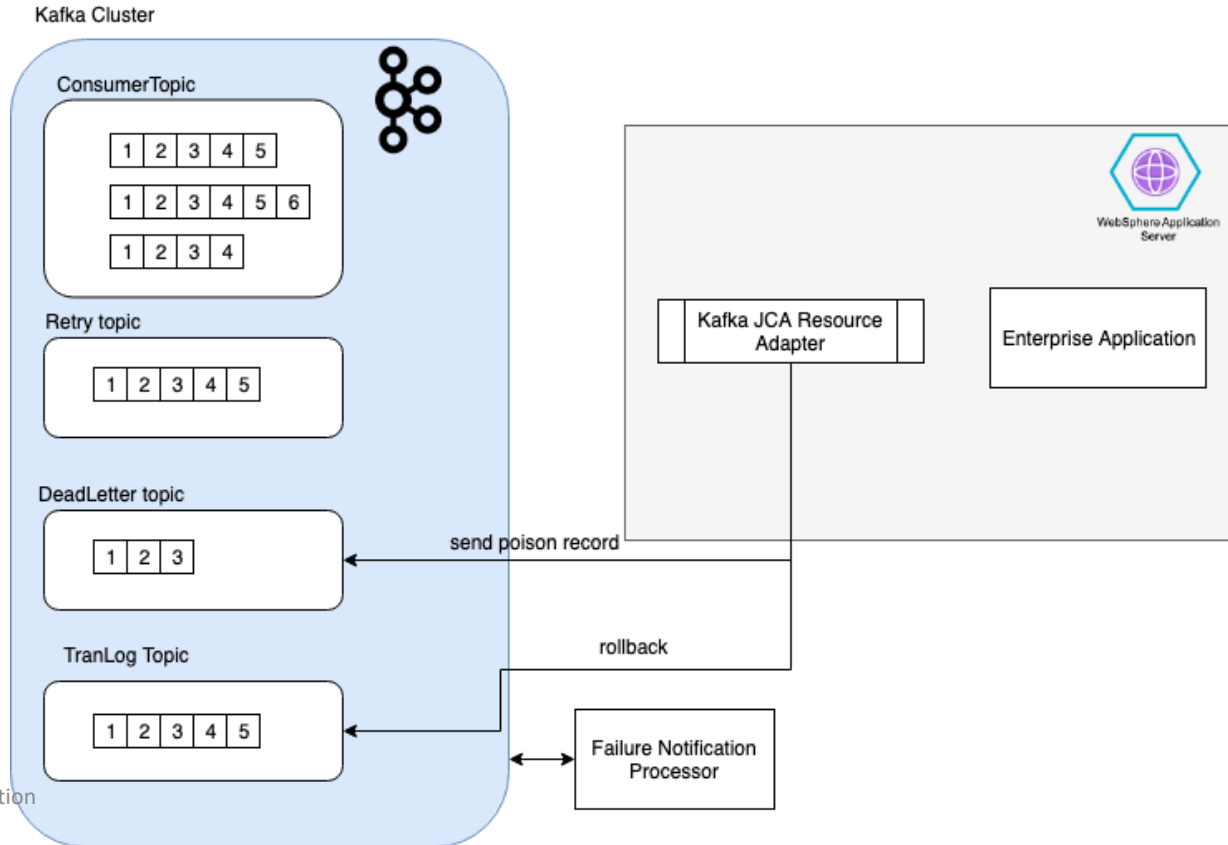

Reliable Kafka Processing

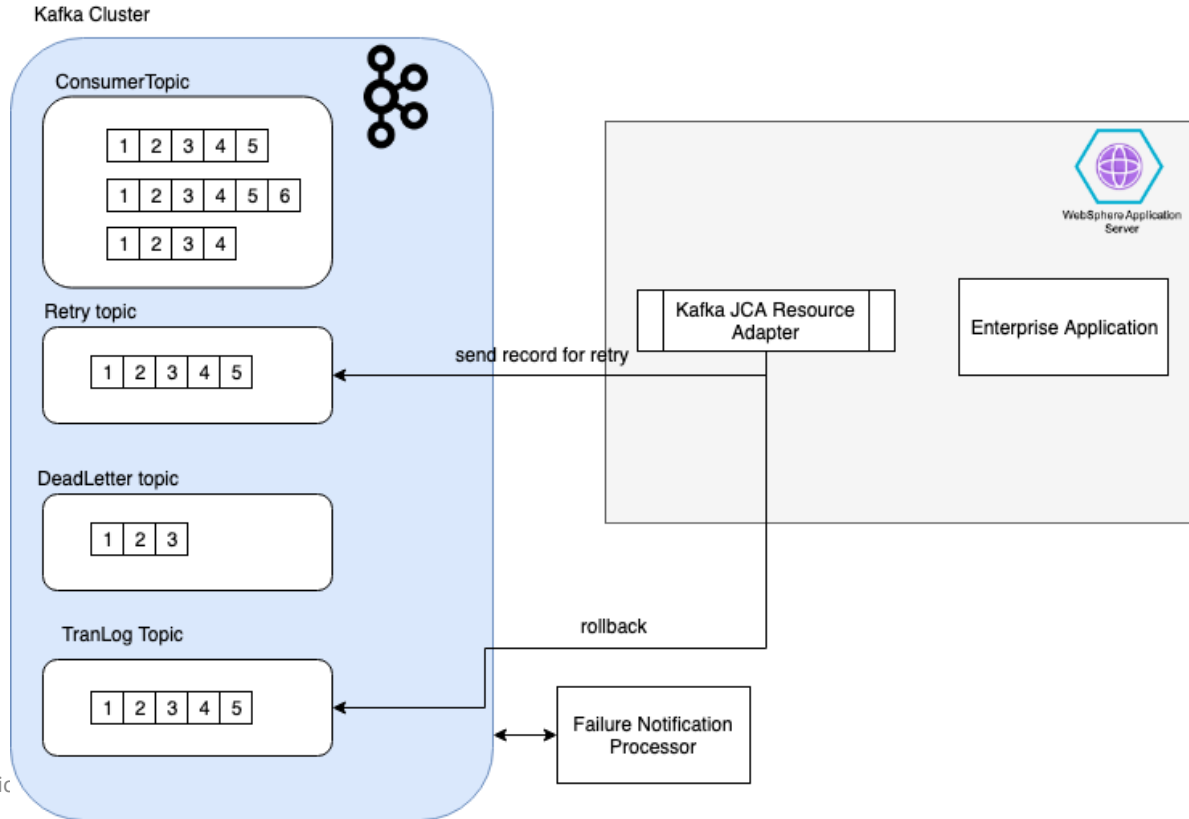

IBM Event Streams

- IBM has years of operational expertise running Apache Kafka for Enterprises
- Event Streams makes Kafka easy to run, manage & consume, reducing skill requirements and raising speed of deployment for faster time to value
- Support you can Trust – IBM has decades of experience supporting the World's toughest environments

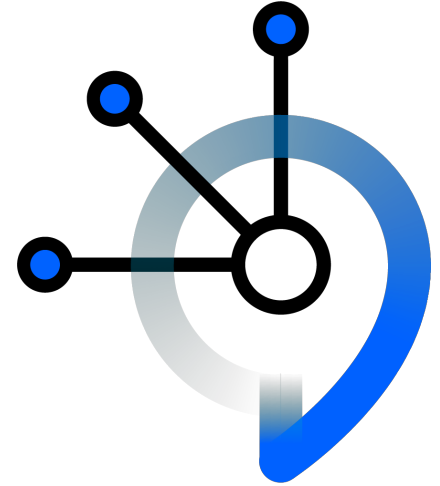

Q&A



anamarija.talijanac@hr.ibm.com

irena.kezic@hr.ibm.com

IBM Event Streams

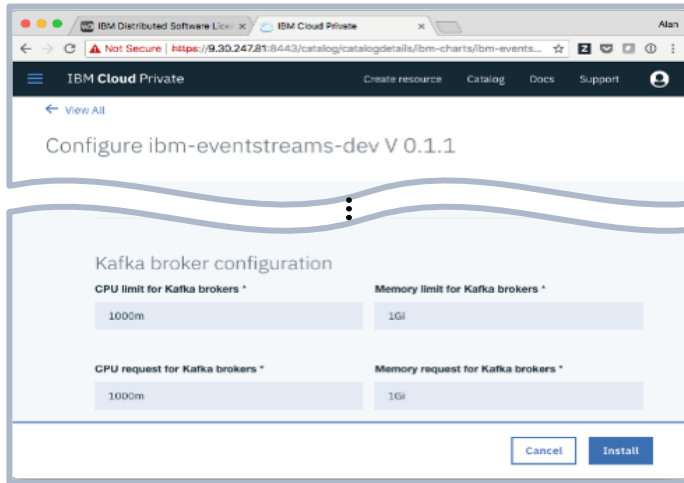

Tools to boost productivity

Visualisation of your topic data

